

SAINT-GOBAIN

GLASS

SGG BIOCLEAN[®] 

Products compatible with sgg BIOCLEAN[®]

Update May 2011





Introduction:

This technical guide update has the aim to give practical information on glazing materials that are compatible with SGG BIOCLEAN® during the glazing work and after.

For any product, guidance should be sought from the supplier regarding its suitability as a glazing material, or its compatibility with other glazing materials. The glazing method should also take into account the recommendations given in relevant national standards, regulations, codes of practice and recommendations of the manufacturer or supplier of the glazing material. If you have any further questions, please contact your Saint-Gobain Glass Sales Manager. Please regularly check on www.saint-gobain-glass.com or www.selfcleaningglass.com that this version is the latest update.

The products mentioned in this document were compatible with SGG BIOCLEAN® at the date of the test. It is fully recommended to check with the supplier that the product hasn't been modified since that date. Saint-Gobain Glass is not responsible for any modification.

Disclaimer: This information is provided by Saint-Gobain Glass for general information purposes only without any warranty or representation. Any use of such information is made strictly at your own risk.

Contents:

1. Conventional windows with 4 sides framed, curtain walls...	3
1.1 Wet sealant	4
1.2 Gasket	5
1.3 Lubricant for gasket	9
1.4 Window system	10
1.5 Construction / frame wet sealant	11
1.6 Sealant for Double Glazing Unit	11
2. Glass to glass sealing: monolithic and laminated glazing	12
2.1 Glass to Glass sealant for monolithic glazing	13
2.2 Glass to Glass sealant for laminated glazing	14
3. Strips, Décor, Leading and Tape	15
4. Structural glazing / Protective films	17
4.1 Protective films	18
4.2 Glass to glass sealing	18
5. Cleaning agents	19

1. Conventional windows with 4 sides framed, curtain walls...

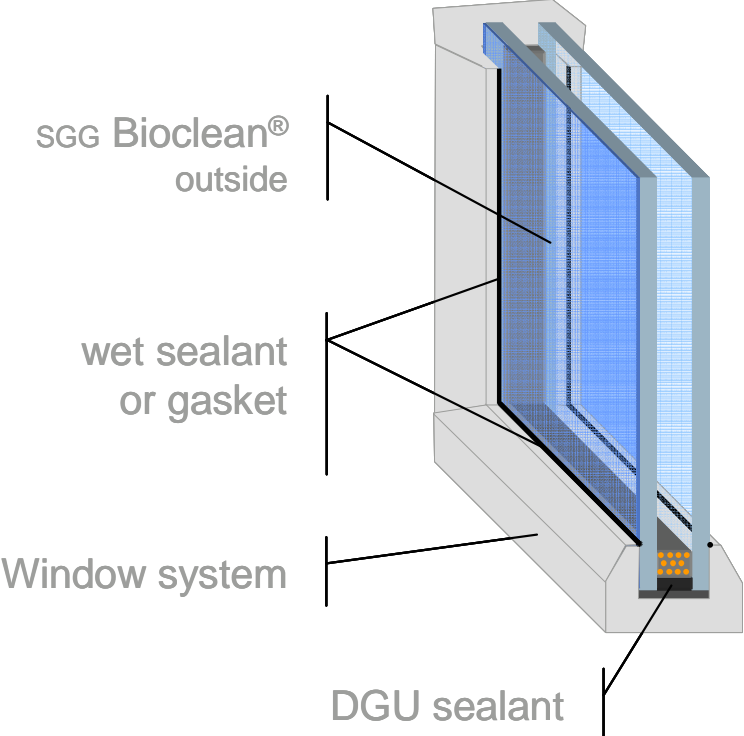



1. Conventional windows with 4 sides framed, curtain walls...

1/8

1.1. Wet sealant:

The products mentioned in the table below are compatible with SGG BIOCLEAR® at the indicated date of test. It is fully recommended to check with the supplier that the product hasn't been modified since that date. Saint-Gobain Glass is not responsible for any modification.

Glass to frame sealing					
Important: There are no silicone sealants compatible with SGG BIOCLEAR®. Product alternatives are either the SCG Tec or MS-Polymer or Hybrid based sealants below.					
Family	Supplier	Reference	Comment	Date tested	Internet
Hybrid-Polymer	ATE	Sealclean	SNJF G25E ISO EN 11600 G25 Adhesion: ISO EN 11431	08/2007	www.atedistribution.com
Hybrid-Polymer	Dana Lim A/S	SCG Sealer 521	SNJF G25E ISO EN 11600 G25 Adhesion: ISO EN 11431	08/2007	www.danalim.dk
Hybrid-Polymer	Dow Corning	DC 757 Black	ISO EN 11600 G25LM Adhesion: ISO EN 11431	01/2008	www.dowcorning.com
Hybrid-Polymer	Fenoplast Fügetechnik	 Fenotherm black	ISO EN 11600 G25 LM Adhesion: ISO EN 11431	04/2010	www.fenoplast.de
Hybrid-Polymer	Henkel	Ceresit F158 Rubson 158	ISO EN 11600 25LM Adhesion: ISO EN 11431	03/2006	www.teroson-bautechnik.de www.henkelbuildingsystems.co.uk
Hybrid-Polymer	Merz + Benteli AG	Merbenit UV27* black	ISO EN 11600 G25 SNJF G25E Adhesion: ISO EN 11431	08/2007	www.merz-benteli.ch
Silikonprofil	Sika Engineering Silicones	 Sikasil WS-680 SC	ISO EN 11600 G25 LM Adhesion: ISO EN 11431	04/2010	www.sika.com
SCG TEC®	Soudal	 SMX® 506 black	ISO EN 11600 20LM Adhesion: ISO EN 11431	04/2010	www.soudal.com

* New name

Conventional windows with 4 sides framed, curtain walls...

2/8

1.2. Gasket (1/4):

The products mentioned in the table below are compatible with SGG BIOCLEAN® at the indicated date of test. It is fully recommended to check with the supplier that the product hasn't been modified since that date. Saint-Gobain Glass is not responsible for any modification.

Dry Glazing system					
Important: prevent any use of silicone oiled gasket. Prefer the gaskets listed below, dry or lubricated without silicone oil.					
Family	Supplier	Reference	Comment	Date tested	Internet
EPDM	Alfaplast AG	Unterlegband Typ I SP 3995	dry	06/2007	www.alfaplast.ch
EPDM	Alfaplast AG	Rippendichtung Typ II SP3990	dry	06/2007	www.alfaplast.ch
EPDM	Dätwyler	3540	Dry	12/2003	www.rubber-plastic.ch
EPDM	Dätwyler	3548	Dry	12/2003	www.rubber-plastic.ch
TPE	Deceuninck	TPE	Dry	09/2003	www.deceuninck.com
EPDM	Deceuninck	S4033 P3299-L2	Dry	05/2007	www.deceuninck.com
EPDM	Deflex - Dichtsysteme	DDS	Dry	09/2003	www.deflex.de/eng/index2.html
EPDM	Deflex - Dichtsysteme	DDS	slipping with soap emulsion	09/2003	www.deflex.de/eng/index2.html
EPDM	Deflex - Dichtsysteme	DDS	slipping with sliding polymer	09/2003	www.deflex.de/eng/index2.html
TPE	Deventer	TPE 1 SEBS	Dry	09/2003	www.deventer-profile.com
TPE	Deventer	TPE vulcanised	Dry	09/2003	www.deventer-profile.com
TPE	Deventer	TPE 2 SEBS	Dry	09/2003	www.deventer-profile.com
EPDM	Exitex	Hip / Valley - gasket	slipping with glycerol	10/2006	www.exitex.com
EPDM	Exitex	DGBS capex - gasket	dry	10/2006	www.exitex.com
EPDM	Exitex	LS - gasket (with glue strip)	dry	10/2006	www.exitex.com
EPDM	GTG-Schüco	GTG - dry	Dry	12/2003	www.gtg-group.com
EPDM	GTG-Schüco	GTG with "slipping polymer"	slipping polymer	12/2003	www.gtg-group.com
EPDM	GTG-Schüco	GTG with "slipping lacker"	slipping lacker	12/2003	www.gtg-group.com
EPDM	GTG-Schüco	GTG "promolisiert"	Dry	12/2003	www.gtg-group.com
EPDM	Hutchinson	3582	Dry	12/2003	www.hutchinsonrubber.com
EPDM	Hutchinson	3583	Dry	12/2003	www.hutchinsonrubber.com
EPDM	Hutchinson	dry EPDM	Dry	12/2003	www.hutchinsonrubber.com
EPDM	Hutchinson	Talc EPDM	Talc slipping	12/2003	www.hutchinsonrubber.com



.../...

1. Conventional windows with 4 sides framed, curtain walls...

3/8

1.2. Gasket (2/4):

The products mentioned in the table below are compatible with SGG BIOCLEAR® at the indicated date of test. It is fully recommended to check with the supplier that the product hasn't been modified since that date. Saint-Gobain Glass is not responsible for any modification.





Dry Glazing system					
Important: prevent any use of silicone oiled gasket. Prefer the gaskets listed below, dry or lubricated without silicone oil.					
Family	Supplier	Reference	Comment	Date tested	Internet
Dry gasket	INEOS (Hydro)	 CO-extruded Gasket Vaycron XA77833	/	09/2008	www.hydropolymers.com
EPDM	Linear	4058 - 101	Dry	12/2003	www.linear.fr
EPDM	Linear	4100 - 101	Dry	12/2003	www.linear.fr
EPDM	Linear	4058 - 101	slightly lubricated	12/2003	www.linear.fr
EPDM	Linear	4100 - 101	slightly lubricated	12/2003	www.linear.fr
EPDM, talc	Otto Wolff Kunststoffvertrieb	"ribs-gasket" 132 513G	Talc slipping	03/2005	www.otto-wolff.de
EPDM, talc	Otto Wolff Kunststoffvertrieb	"ribs-gasket" 132 515G	Talc slipping	03/2005	www.otto-wolff.de
EPDM, talc	Otto Wolff Kunststoffvertrieb	"ribs-gasket" 132 516G	Talc slipping	03/2005	www.otto-wolff.de
EPDM, talc	Otto Wolff Kunststoffvertrieb	"ribs-gasket" 132 518G	Talc slipping	03/2005	www.otto-wolff.de
EPDM, talc	Otto Wolff Kunststoffvertrieb	"ribs-gasket" 132 520G	Talc slipping	03/2005	www.otto-wolff.de
EPDM, talc	Otto Wolff Kunststoffvertrieb	"ribs-gasket" 132 522G	Talc slipping	03/2005	www.otto-wolff.de
EPDM, talc	Otto Wolff Kunststoffvertrieb	"ribs-gasket" 132 523G	Talc slipping	03/2005	www.otto-wolff.de
EPDM, talc	Otto Wolff Kunststoffvertrieb	"mushroom-gasket" 1935	Talc slipping	03/2005	www.otto-wolff.de
EPDM, talc	Otto Wolff Kunststoffvertrieb	"lips-gasket"	Talc slipping	03/2005	www.otto-wolff.de
EPDM	Reddiglaze	3231	dry	10/2003	www.reddiplex.co.uk
EPDM	Reddiglaze	3234	dry	10/2003	www.reddiplex.co.uk
EPDM	Reddiglaze	3237	dry	10/2003	www.reddiplex.co.uk
EPDM	Reddiglaze	9028	slightly lubricated	10/2003	www.reddiplex.co.uk
Dry Silicone	Saint-Gobain SIPRO	Siproslide	treated	08/2005	www.silicone.saint-gobain.com
EPDM	SAPA Building Systems	 RU 1027	Origin Hutchinson (FIT)	11/2008	www.sapabuildingsystems.co.uk

.../...

1. Conventional windows with 4 sides framed, curtain walls...

1.2. Gasket (3/4):

The products mentioned in the table below are compatible with SGG BIOCLEAN® at the indicated date of test. It is fully recommended to check with the supplier that the product hasn't been modified since that date. Saint-Gobain Glass is not responsible for any modification.



Dry Glazing system					
Important: prevent any use of silicone oiled gasket. Prefer the gaskets listed below, dry or lubricated without silicone oil.					
Family	Supplier	Reference	Comment	Date tested	Internet
EPDM	Schlegel BVBA Belgium	 SCH070539		11/2008	www.schlegel.be
EPDM	Semperit	2600	dry	11/2003	www.semperit.at/en.html
EPDM	Semperit	2631	dry	11/2003	www.semperit.at/en.html
EPDM	Semperit	2633	dry	11/2003	www.semperit.at/en.html
EPDM, talc	Semperit	2600	Talc slipping	11/2003	www.semperit.at/en.html
EPDM, talc	Semperit	2604	Talc slipping	11/2003	www.semperit.at/en.html
EPDM, talc	Semperit	2631	Talc slipping	11/2003	www.semperit.at/en.html
EPDM, talc	Semperit	2633	Talc slipping	11/2003	www.semperit.at/en.html
EPDM	Semperit	1 4473 30	dry	04/2007	www.semperit.at/en.html
EPDM	Semperit	5 6483 30	dry	04/2007	www.semperit.at/en.html
EPDM	Semperit	M4605	PMMA	07/2007	www.semperit.at/en.html
EPDM	Semperit	M4616	slipping with Struktol VP5289	07/2007	www.semperit.at/en.html
EPDM	Semperit	 M4610	slipping with Getren P3300	06/2008	www.semperit.at/en.html
Dry silicone gasket	SGPP Sipro	 Siproslide black	treated	06/2008	www.sipro.de
Dry silicone gasket	Silex	 Silicone foam profile red brown		06/2008	www.silex-silikon.de
PVC-U	Spectus Systems	unsiliconised PVC-U	dry	09/2003	www.spectusystems.com
EPDM	Syncamer	EPDM Typ 150443	dry	12/2006	www.syncamer.de
EPDM	Thyssen Polymer	DRF 4 IE	dry	06/2004	www.inoutic.com
EPDM	TPP BV	EasySet PT505	Dry gasket	10/2005	www.tpp-bv.com

.../...

1. Conventional windows with 4 sides framed, curtain walls...

1.2. Gasket (4/4):

The products mentioned in the table below are compatible with SGG BIOCLEAN® at the indicated date of test. It is fully recommended to check with the supplier that the product hasn't been modified since that date. Saint-Gobain Glass is not responsible for any modification.

Dry Glazing system					
Important: prevent any use of silicone oiled gasket. Prefer the gaskets listed below, dry or lubricated without silicone oil.					
Family	Supplier	Reference	Comment	Date tested	Internet
EPDM	Trelleborg	EPDM dry	dry	09/2003	www.trelleborg.com/industrialprofiles
EPDM	Trelleborg	EPDM Dipro 2150	Dipro 2150	09/2003	www.trelleborg.com/industrialprofiles
EPDM	Trelleborg	EPDM with soap emulsion	soap emulsion	09/2003	www.trelleborg.com/industrialprofiles
EPDM	Trelleborg	EPDM Cellular Strip Untreated	slipping with Cellular Strip	06/2004	www.trelleborg.com/industrialprofiles
EPDM	Trelleborg	EPDM with potatoes starch	slipping with Potatoes starch	06/2004	www.trelleborg.com/industrialprofiles
EPDM	Trelleborg	EPDM one side treated	slipping with Antifric	06/2004	www.trelleborg.com/industrialprofiles
EPDM	Tremco	Peroxide EPDM 65	dry	12/2004	www.tremcosealants.com
EPDM	Tremco	70 Duro EPDM	dry	12/2004	www.tremcosealants.com
EPDM	Tremco	60 Duro EPDM	dry	12/2004	www.tremcosealants.com
EPDM	Tremco	SCR 900-70	dry	12/2004	www.tremcosealants.com
EPDM	VEKA	Extruded EPDM	dry	06/2003	www.veka.de
<i>EPDM</i>	<i>Wibra-Plast</i>	 <i>A-Quality colours grey / black</i>		04/2010	www.wibra-plast.de
<i>EPDM</i>	<i>Wibra-Plast</i>	 <i>AA-Quality colours grey / black</i>		04/2010	www.wibra-plast.de





.../...

1. Conventional windows with 4 sides framed, curtain walls...

6/8

1.3. Lubricant for Gasket:

The products mentioned in the table below are compatible with SGG BIOCLEAN® at the indicated date of test. It is fully recommended to check with the supplier that the product hasn't been modified since that date. Saint-Gobain Glass is not responsible for any modification.

Lubricants for dry glazing systems					
Family	Supplier	Reference	Comment	Date tested	Internet
Spray	Deflex Dichtsysteme	Gummispray A1		05/2008	www.deflex.de
Spray	Deflex-Dichtsysteme	Gummispray A1		05/2008	www.deflex.de
Liquid	Evonik Industries	 Gleitpolymer P 3300		06/2008	www.evonik.com
Liquid	Evonik Industries	 Gleitpolymer P3200N		06/2009	www.evonik.com
Liquid	Evonik Industries	 Gleitpolymer P3500	sliding polymer for the industrial application	4/2010	www.evonik.com
Liquid	Evonik Industries	 Gleitpolymer B7100	liquid aid for the assembly	04/2010	www.evonik.com
Liquid	Hutchinson	Tekskin		12/2003	www.deutsche-hutchinson.de
Liquid	Phoenix	Renoclean		12/2005	www.phoenix-ag.com
Liquid	Phoenix	Unislip		12/2005	www.phoenix-ag.com
Liquid	Schill & Seillacher	Struktol VP5289		07/2007	www.struktol.de
Spray	Würth	Dichtstoffglättemittel		11/2008	www.wuerth.com

.../...

1. Conventional windows with 4 sides framed, curtain walls...

7/8

1.4. Window system:

The products mentioned in the table below are compatible with SGG BIOCLEAR® at the indicated date of test. It is fully recommended to check with the supplier that the product hasn't been modified since that date. Saint-Gobain Glass is not responsible for any modification.

Windows System					
Family	Supplier	Reference	Comment	Date tested	Internet
PVC	Aluplast	gasket 749082 TPE		12/2005	www.aluplast.de
PVC	Aluplast	extruded gasket DN-49001		12/2005	www.aluplast.de
PVC	Alwo	profile with EPDM "ribs-gasket"		03/2005	www.Otto-Wolff.de
PVC	Dimex	PCE extruded gasket		12/2005	www.veka.de
PVC	GEALAN	co-extruded, weldable		03/2003	www.gealan.de
PVC	Profine - KBE	EPDM (silicone-free) gaskets 9044 SF; 9045 SF		02/2004	www.kbe-online.de
PVC	Profine - Kömmerling	EPDM (silicone-free) gaskets 9044.1, 9045 SF		03/2004	www.koemmerling.de
PVC	Salamander	Modell Brügmann	only with gasket No. DP 204	10/2006	www.sip.de
PVC	Salamander	Modell I-Design	only with gasket No. 414 633	10/2006	www.sip.de

.../...

1. Conventional windows with 4 sides framed, curtain walls...

1.5. Construction / Frame wet sealant:

The products mentioned in the table below are compatible with SGG BIOCLEAR® at the indicated date of test. It is fully recommended to check with the supplier that the product hasn't been modified since that date. Saint-Gobain Glass is not responsible for any modification.

Construction / Frame Sealant					
Important: NO silicone sealant. SGG BIOCLEAR® functionality can be altered due to water run-off polluted by silicones oils.					
Family	Supplier	Reference	Comment	Date tested	Internet
Hybrid-Polymer	Dow Corning	DC 757 Black	ISO EN 11600 G25LM Adhesion: ISO EN 11431	01/2008	www.dowcorning.com
Hybrid-Polymer	Fenoplast Fügetechnik	 Fenotherm black	ISO EN 11600 G25 LM Adhesion: ISO EN 11431	04/2010	www.fenoplast.de
Hybrid-Polymer	Merz + Benteli	Merbenit UV27* black	ISO EN 11600 G25 SNJF G25E Adhesion: ISO EN 11431	08/2007	www.merz-benteli.ch
MS-Polymer	Soudal	Soudaseal LM 215		06/2003	www.soudal.com

* New name

1.6. Sealant for Double Glazing Unit:

The products mentioned in the table below are compatible with SGG BIOCLEAR® at the indicated date of test. It is fully recommended to check with the supplier that the product hasn't been modified since that date. Saint-Gobain Glass is not responsible for any modification.

Sealant for Double Glazing Unit
Usual sealant used for DGUs are: polysulphides, polyurethanes, hot melt and butyls. They are compatible with SGG BIOCLEAR®. Prevent any use of silicone sealant.

2. Glass to glass sealing: monolithic AND laminated glazing

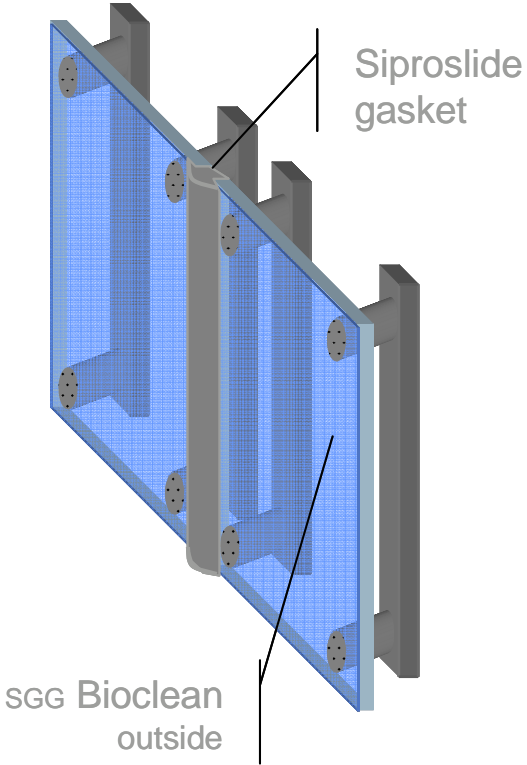
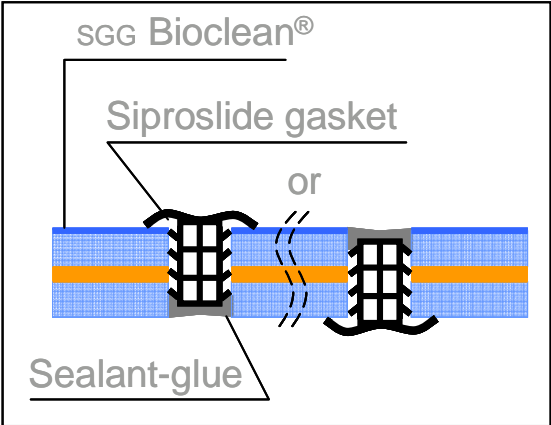
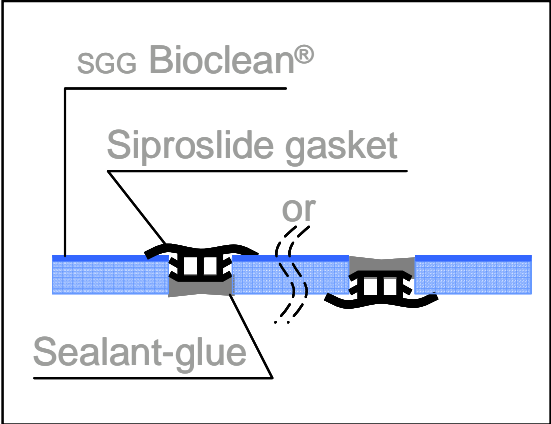

2. Glass to glass sealing: monolithic AND laminated glazing

1/2

2.1. Glass to glass sealant for monolithic glazing:

The products mentioned in the table below are compatible with SGG BIOCLEAN® at the indicated date of test. It is fully recommended to check with the supplier that the product hasn't been modified since that date. Saint-Gobain Glass is not responsible for any modification.

Glass / Glass sealing: Monolithic glass					
Important: To fix the gasket it is necessary to use a sealant-glue component.					
Family	Supplier	Reference	Comment	Date tested	Internet
Hybrid-Polymer	Dow Corning	DC 757 Black	Sealant/glue used to fix the gasket. Can be used either on the outer or inner side of the glazing.	01/2008	www.dowcorning.com
Hybrid-Polymer	Henkel	Ceresit F158 Rubson 158	Sealant/glue used to fix the gasket. Can be used either on the outer or inner side of the glazing.	03/2006	www.teroson-bautechnik.de www.henkelbuildingsystems.co.uk
Hybrid-Polymer	Merz + Benteli	Merbenit UV27* black	Sealant/glue used to fix the gasket. Can be used either on the outer or inner side of the glazing.	08/2007	www.merz-benteli.ch
Dry Silicone	Saint-Gobain SIPRO	Siproslide	treated	08/2005	www.silicone.saint-gobain.com
MS Polymer	Soudal	SODASEAL 4 All Paint	Sealant/glue used to fix the gasket. SGG strongly recommend to have gasket on the outer side so that the sealant is protected from UV.	01/2005	www.soudal.com

* New name



.../...

2. Glass to glass sealing: monoglazing AND laminated

2/2

2.2. Glass to glass sealant for laminated glazing:

The products mentioned in the table below are compatible with SGG BIOCLEAR® at the indicated date of test. It is fully recommended to check with the supplier that the product hasn't been modified since that date. Saint-Gobain Glass is not responsible for any modification.

Glass / Glass sealing: Laminated glass					
Important: To fix the gasket it is necessary to use a sealant-glue component compatible with the PVB interlayer.					
Family	Supplier	Reference	Comment	Date tested	Internet
Hybrid-Polymer	Dow Corning	DC 757 Black	Sealant/glue used to fix the gasket. Can be used either on the outer or inner side of the glazing.	01/2008	www.dowcorning.com
Hybrid-Polymer	Fenoplast Fügetechnik	 Fenotherm black		04/2010	www.fenoplast.de
Hybrid-Polymer	Henkel	Ceresit F158 Rubson 158	Sealant/glue used to fix the gasket. Can be used either on the outer or inner side of the glazing.	03/2006	www.teroson-bautechnik.de www.henkelbuildingsystems.co.uk
Hybrid-Polymer	Merz & Benteli	Merbenit UV27* black	Sealant/glue used to fix the gasket. Can be used either on the outer or inner side of the glazing.	08/2007	www.merz-benteli.ch
dry silicone gasket	Saint-Gobain SIPRO	Siproslide	treated	08/2005	www.silicone.saint-gobain.com
Silikonprofil	Sika Engineering Silicones	 Sikasil WS-680 SC		04/2010	www.sika.com

* New name



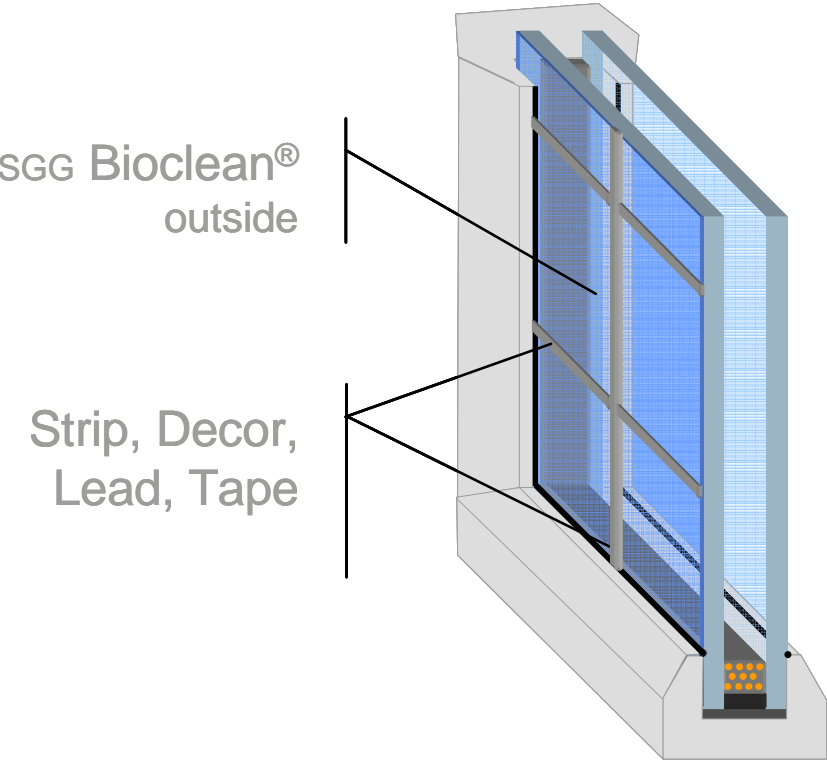

3. Strips, Décor, Leading, Tape...



3. Strips, Décor, Leading, Tape...

1/1

The products mentioned in the table below are compatible with SGG BIOCLEAN® at the indicated date of test. It is fully recommended to check with the supplier that the product hasn't been modified since that date. Saint-Gobain Glass is not responsible for any modification.

Strips-Décor-Leading-Tapes / Glues and sealants for strips for Strips-Décor-Leading-Tapes					
Family	Supplier	Reference	Comment	Date tested	Internet
AcrylicTape	3M	4941	1,1 mm; grey adhesive	10/2003	www.mmm.com
AcrylicTape	3M	4905	0,5 mm; transparent adhesive	10/2003	www.mmm.com
AcrylicTape	3M	4910	1,0 mm; transparent adhesive	10/2003	www.mmm.com
MS-Polymer	Adshead Ratcliffe	Arboseal GZ	black	11/2003	www.arbo.co.uk
MS-Polymer	Adshead Ratcliffe	Arbomeric MP 10	brown	11/2003	www.arbo.co.uk
MS-Polymer	Adshead Ratcliffe	Arbosil 1070	grey	11/2003	www.arbo.co.uk
Tape	Henkel	 TS-Alu Fixband	Sealing tape	09/2008	www.teroson-building.com
Tape	Innotec	Moulding Tape		08/2006	www.innotec-industrie.nl
Tape	Innotec	Clear Mount Tape		08/2006	www.innotec-industrie.nl
Tape	Lohmann	Duplomont 9183	glue for strips	10/2003	www.lohmann-tapes.co.uk
Tape	Lohmann	Duplomont 918	glue for strips	10/2003	www.lohmann-tapes.co.uk
MS-Polymer	SIKA	Sikafast 5215	PU-Hybrid glue	11/2003	www.sika-industry.com
MS-Polymer	Soudal	Soudaseal 4 All Paint	MS-Polymer	01/2004	www.soudal.com
Tape	Tesa	 Tesa 4316	tape	07/2010	www.tesa.com
Tape	Tesa	 Tesa 4323	tape	07/2010	www.tesa.com
Tape	Tesa	 Tesa 4438	tape	07/2010	www.tesa.com
Tape	Thermoseal	Lead-Tape		08/2006	www.thermosealgroup.com

4. Structural glazing / Protective films:

Glass to Glass sealing:

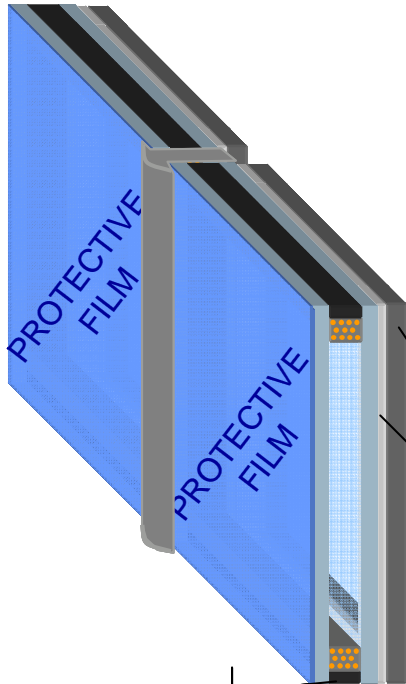
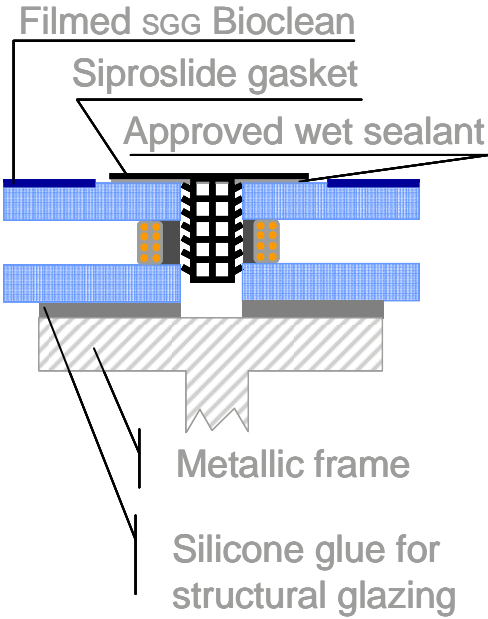

Metallic frame
 Silicone glue for structural glazing



⇒ **FILMING OF BIOCLEAN COMPULSORY PRIOR TO ENDUCTION**

4. Structural glazing / Protective films:

1/1

4.1. Protective films

The products mentioned in the table below are compatible with SGG BIOCLEAN® at the indicated date of test. It is fully recommended to check with the supplier that the product hasn't been modified since that date. Saint-Gobain Glass is not responsible for any modification.

Protective film					
Family	Supplier	Reference	Comment	Date tested	Internet
PE-Film	Novacel	Novacel 4331, transparent	ready to use	2006	www.novacel.de
PE-Film	Poli-Film	3x3-304 CLV, transparent	ready to use	2006	www.poli-film.de

3.2. Glass to glass sealant for structural glazing

The products mentioned in the table below are compatible with SGG BIOCLEAN® at the indicated date of test. It is fully recommended to check with the supplier that the product hasn't been modified since that date. Saint-Gobain Glass is not responsible for any modification.

Glass / Glass sealing: Double Glazing Unit					
Important: Silicone sealant for DGUs can not be used. Take care to use a SIPROSLIDE gasket wide enough to cover totally the edge of the DGU.					
Family	Supplier	Reference	Comment	Date tested	Internet
Hybrid-Polymer	Merz + Benteli	Merbenit UV27 black	Sealing between gasket and Bioclean	08/2007	www.merz-benteli.ch
Hybrid-Polymer	Dow Corning	DC 757 Black	Sealing between gasket and Bioclean	01/2008	www.dowcorning.com
dry silicone gasket	Saint-Gobain SIPRO	Siproslide	treated	08/2005	www.silicone.saint-gobain.com
MS Polymer	Soudal	SODASEAL 4 All Paint	Sealing between gasket and Bioclean	01/2005	www.soudal.com

* New name



5. Cleaning Agents / Miscellaneous



5. Cleaning Agents / Miscellaneous

1/2



The products mentioned in the table below are compatible with SGG BIOCLEAR® at the indicated date of test. It is fully recommended to check with the supplier that the product hasn't been modified since that date. Saint-Gobain Glass is not responsible for any modification.

Cleaning Agents:					
All glass cleaners based on alcohol or ammoniac are suitable for the use with SGG BIOCLEAR®. Silicon based or abrasive (scrubbing) cleaners are not suitable.					
Family	Supplier	Reference	Comment	Date tested	Internet
Liquid		Isopropanol	Please respect the safety instruction	04/2010	
Liquid		Ethanol	Please respect the safety instruction	04/2010	
Liquid		Acetone	Please respect the safety instruction	04/2010	
Micro fiber	Aldi	Optiwisch Universal cloth	ready to use	2007	www.aldi.co.uk
Micro fiber	Aldi	Optiwisch Polish- & mirror cloth	ready to use	2007	www.aldi.co.uk
Spray	Aldi	Zekol Glasscleaner foam	ready to use	2007	www.aldi.co.uk
Liquid	Colgate-Palmolive	Ajax ruby red grapefruit	ready to use	2004	www.ajax.com
Liquid	Dow Corning	Silicon remover; not leaching	ready to use	2004	www.dowcorning.de
Liquid	Fenoplast	Fenosol S10	ready to use	2004	www.fenoplast.net
Liquid	Harris	 Mousse Suractive Insert	Glasscleaner for stoves	11/2008	www.harris.fr
Liquid	Hevadex	 Glass Renew Super		06/2010	info@hevadex.be
Spray	Innotec	Seal & Bond Remover	ready to use	2006	www.innotec.de
Spray	Innotec	Multi Clean	ready to use	2006	www.innotec.de
Spray	Innotec	Foam Glass Cleaner	ready to use	2006	www.innotec.de
Spray	Innotec	Ultra Clean	ready to use	2006	www.innotec.de
Spray	JohnsonDiversey	Suma Rapid D6	ready to use	2006	www.johnsondiversey.com
Liquid	JohnsonDiversey	Taski Sprint 200 conc E1a	concentrated	2006	www.johnsondiversey.com
Spray	Kema	DL-44 Degreaser	Degreaser	09/2008	www.kema.dk

.../...

5. Cleaning Agents / Miscellaneous

2/2

Cleaner: (only for persistent contamination - not for continuous use suitably / please consider the safety guidelines)					
Only for persistent contamination - not for continuous use suitably / please consider the safety guidelines					
Family	Supplier	Reference	Comment	Date tested	Internet
Liquid	Lever Fabergé	CIF (VISS)	ready to use	2002	www.unilever.com
Liquid	Lidl	W5 glass-cleaner	ready to use	2006	www.lidl.co.uk
Spray	Lidl	W5 Glasscleaner Power-Foam	ready to use	2007	www.lidl.co.uk
Liquid	Liquid Dow Corning	Silicon remover; not leaching	ready to use	2004	www.dowcorning.de
Spray	Novatio Belgium N.V.	Safety Clean	Cleaner & Degreaser	09/2008	www.novatio.com
Liquid	Procter & Gamble	Fairy liquid	ready to use	2002	www.fairy-dish.com
Liquid	Resto Bouwspecialiteiten	Periodi Clean		06/2008	www.restobouw.be
Liquid	Resto Bouwspecialiteiten	Gloss & Protector		06/2008	www.restobouw.be
Spray	Riem	 Insert Spray	Glasscleaner for stoves	09/2008	www.riem.be
Liquid	SC Johnson	Mr Muscle	ready to use	2002	www.scjohnson.co.uk
Spray	Soudal	 Sealant Remover		06/2008	www.soudal.de
Sponge	Spontex	Spontex Glass sponge	ready to use	2004	www.mapa.de
Liquid	Tana Professional	Green Care No. 4	ready to use	2002	www.tana.de
Liquid	Windolene	Windolene cream	ready to use	2002	

Miscellaneous:					
Family	Supplier	Reference	Comment	Date tested	Internet
2 component system	Chemische Baustoffe Gruber	Roypur 315	2-component-PU	06/2008	www.cb-gruber.at
Spray	Würth	 Dichtstoffglättemittel		11/2008	www.wuerth.com